

MVS 35X De-Vac/Air Release

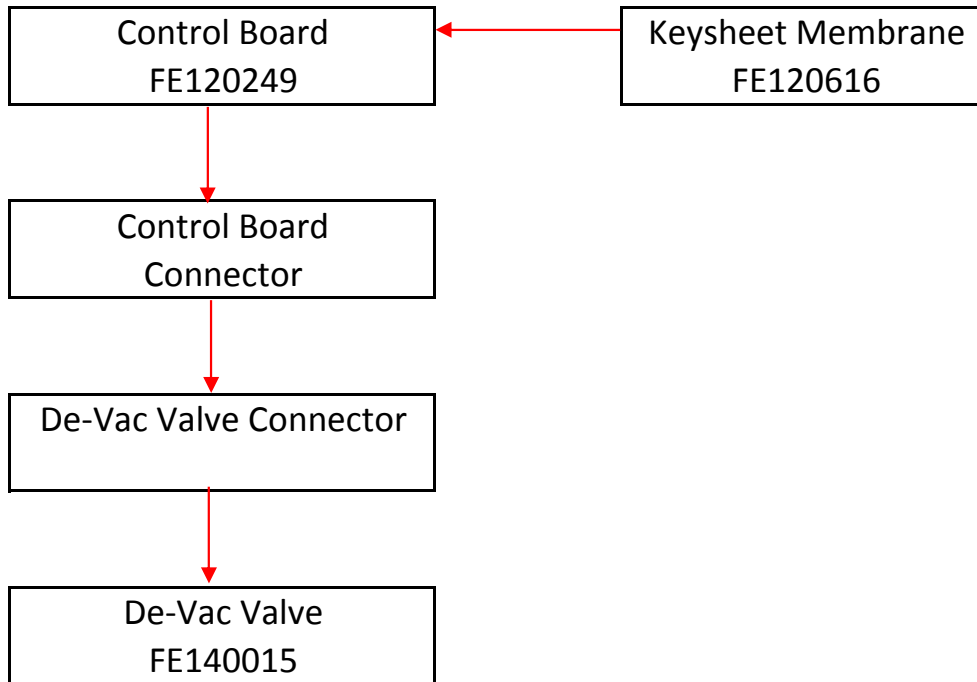

↓ Power and Signal lines
are of the same values
120 volt AC