

MVS 26X De-Vac/Air Release

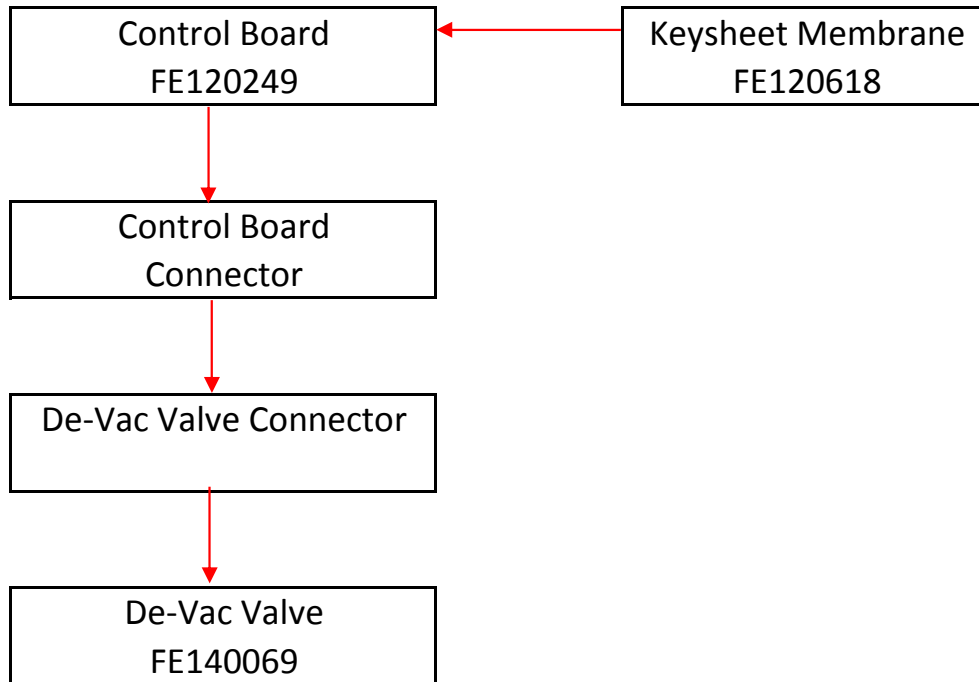

↓ Power and Signal Lines
are of the same values
120 volt AC